



Ø 5 / 8" ... 1" (16 ... 26 mm)

**AHE 7.5 Hollow Shaft**  
Incremental Encoder



# AHE 7.5

**Compact hollow-shaft incremental encoder in rugged all-metal die-cast housing with hollow shaft for monitoring speed or position in drive systems, especially for AC motors**

- **HÜBNER / SIEI America Incremental Encoders** (Digital-Tachos) have over the years become standard in many areas of industry due to their rugged construction adapted to the application (**Heavy Duty Technology**):
- Sensing by **opto-ASIC**, compensated for **temperature** and **aging**
- **Electromagnetic Compatibility (EMC)** according to IEC 801-4
- High **vibration** and **shock resistance** meeting IEC 60068-2-6 and IEC 60068-2-27
- **2 years warranty** within the conditions of the German Electrical Manufacturer's Association (ZVEI)
- **ISO 9001** certified

### Special features:

- Compact **aluminium housing**
- **Bore hollow shaft**  $\varnothing 5/8" \dots 1"$  ( $\varnothing 16 \dots 26 \text{ mm}$ ),  $\varnothing 5/8"$  and  $1"$  on stock
- **Clamping ring left side** (right side option)
- Internal **terminal strip**
- **Logic level HTL** with line driver IC (version C) or +9 ... +26 V (version R with internal regulator) or **logic level TTL** with supply voltage +5 V
- Protection **IP 56**
- **Patent** pending

HTL (Version C)

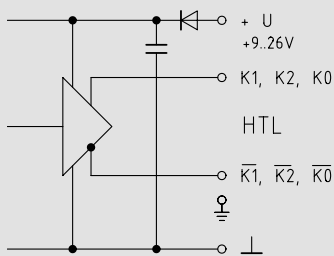

TTL

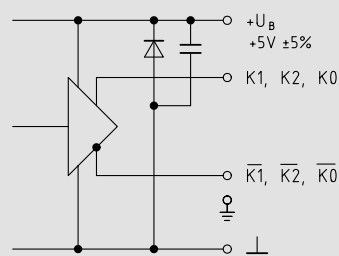

TTL (Version R)

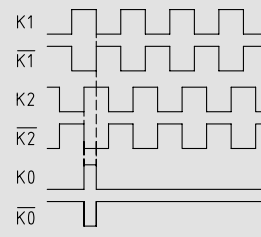
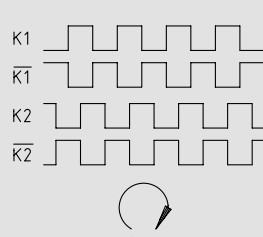
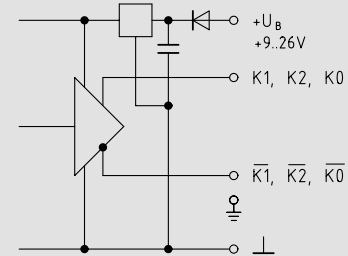

### Ordering key

<b>AHE 7.5 DN ... CI</b>	two inverted TTL signals, displaced by 90° plus marker pulse and inverted signals
<b>AHE 7.5 DN ... TTL</b>	as DN ... CI, but TTL signals
<b>AHE 7.5 DN ... TTL</b>	as DN ... TTL, but supply voltage $U_B = +9 \dots +26 \text{ V}$

Square-wave cycles per turn

## General data

<b>Square-wave cycles/turn</b>	z	<b>1024 stock</b> 1200, 1250, 2048 and 2500 other versions on request
<b>Switching frequency</b>	f <sub>max</sub>	120 kHz
<b>Maximum speed</b>	rpm	electronic: $\frac{7,2 \cdot 10^6}{z}$ mechanical: 10000
<b>Logic level</b>		<b>HTL</b> (Version C) <b>TTL</b> (RS-422)
<b>Supply voltage</b>	U <sub>B</sub>	+9 ... +26 V      +5 V ± 5 %      +9 ... +26 V (Version R)
<b>Current consumption at no-load</b>		≈ 100 mA      ≈ 100 mA
<b>Maximum load current per channel</b>	I <sub>source</sub> = I <sub>sink</sub>	60 mA average 150 mA peak      25 mA average 75 mA peak
<b>Output amplitude</b>		U <sub>Low</sub> ≤ 3 V; U <sub>High</sub> ≥ U <sub>B</sub> - 3,5 V      U <sub>Low</sub> ≤ 0,5 V; U <sub>High</sub> ≥ 2,5 V
<b>Mark space ratio</b>		1 : 1 ± 20 %
<b>Square wave displacement</b>		90° ± 20°
<b>Rise time</b>		≥ 10 V/μs
<b>Moment of inertia</b>		≈ 180 gcm <sup>2</sup>
<b>Driving torque</b>		≈ 4 Ncm
<b>Maximum shaft load</b>		axial 40 N      radial 30 N
<b>Vibration resistance (10 Hz ... 2 kHz)</b>		≤ 100 m/s <sup>2</sup> ≈ 10 g      IEC 60068-2-6
<b>Shock resistance (6 ms)</b>		≤ 1000 m/s <sup>2</sup> ≈ 100 g      IEC 60068-2-27
<b>Permissible encoder temperature</b>		-30 °C ... +70 °C
<b>Protection class</b>		IP 56      IEC 60529
<b>Weight</b>		AHE 7.5 ≈ 320 g

Die elektrischen Daten gelten im gesamten zulässigen Temperaturbereich.  
*The electrical data apply over the entire permissible temperature range.*

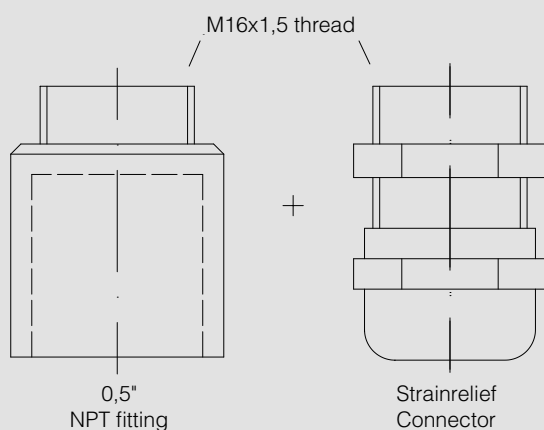

### Accessories:

- Torque arm
- Cable HEK 8 and plug
- Spring disk coupling
- Frequency-analogue converter  
HEAG 121 P
- Opto coupler / logic converters  
HEAG 151 → HEAG 154
- Fiber optic links  
HEAG 171 → HEAG 174

# AHE 7.5

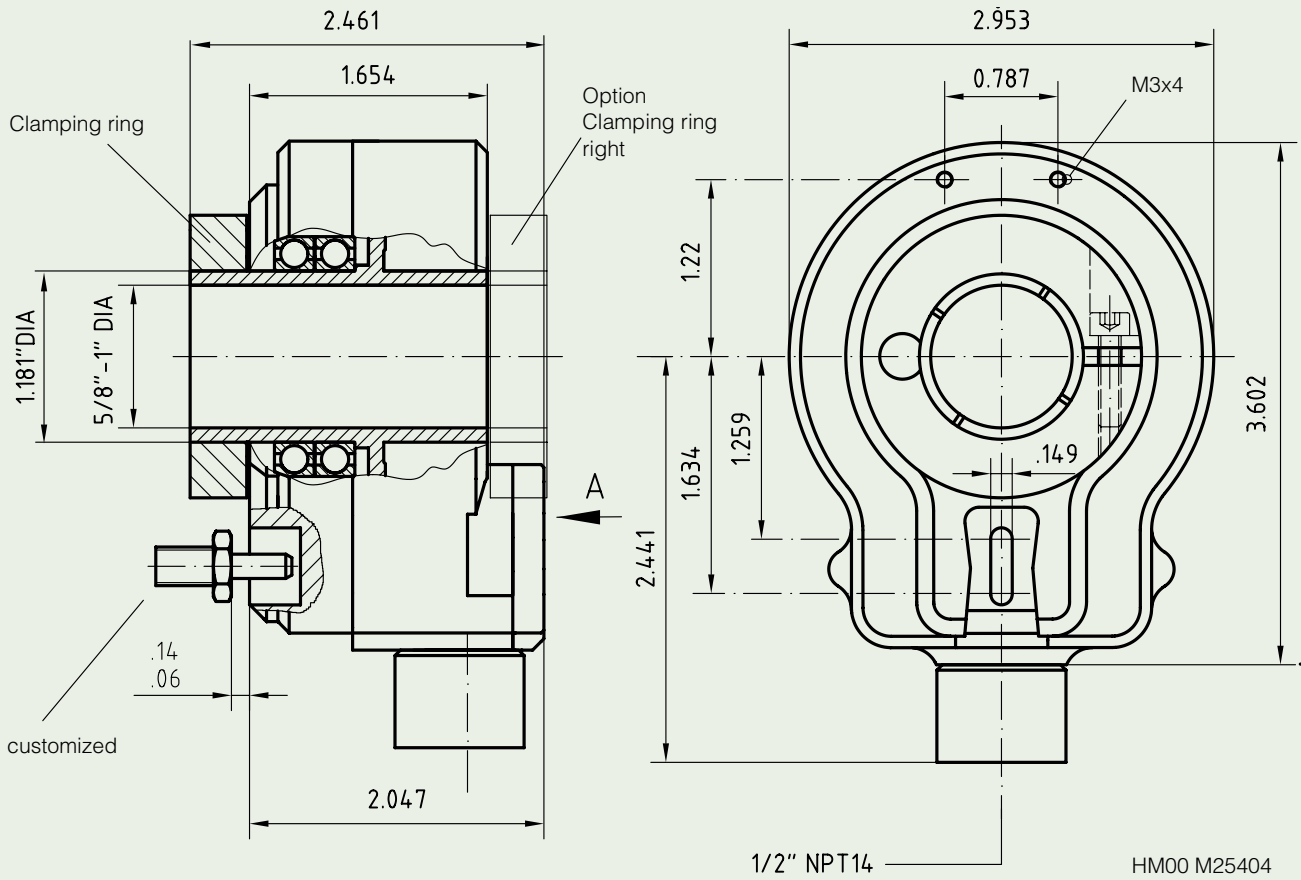

## RAL 7021 (anthracite)

### Mounting Tethers Kits (Torque arms)

Part #	Description
AHE7.5 - T25	25 mm Wide Tether for 5.875" OD Accessory Bolt Circle Marathon Black Max AC Motors, Frames 56 - 284 TENV Only Marathon Blue Max AC Motors, Frames 143 - 256 TENV Only
AHE7.5 - T44	44,5 mm Wide Tether for 7.25" OD Accessory Bolt Circle GE Type KAF AC Motors, Frames 182 - 365

